

## Structure–Activity Relationships (SAR) Studies of Benzoxazinones, Their Degradation Products and Analogues. Phytotoxicity on Standard Target Species (STS)

FRANCISCO A. MACÍAS,\* DAVID MARÍN, ALBERTO OLIVEROS-BASTIDAS,<sup>†</sup>  
DIEGO CASTELLANO, ANA M. SIMONET, AND JOSÉ M. G. MOLINILLO

Grupo de Alelopatía, Departamento de Química Orgánica, Facultad de Ciencias,  
Universidad de Cádiz. C/República Saharaui, s/n, 11510 Puerto Real, Cádiz, Spain

Benzoxazinones 2,4-dihydroxy-7-methoxy-(2*H*)-1,4-benzoxazin-3(4*H*)-one (DIMBOA) and 2,4-dihydroxy-(2*H*)-1,4-benzoxazin-3(4*H*)-one (DIBOA) have been considered key compounds for understanding allelopathic phenomena in Gramineae crop plants such as corn (*Zea mays* L.), wheat (*Triticum aestivum* L.), and rye (*Secale cereale* L.). The degradation processes in the environment observed for these compounds, in which soil microbes are directly involved, could affect potential allelopathic activity of these plants. We present in this work a complete structure–activity relationships study based on the phytotoxic effects observed for DIMBOA, DIBOA, and their main degradation products, in addition to several synthetic analogues of them. Their effects were evaluated on standard target species (STS), which include *Triticum aestivum* L. (wheat) and *Allium cepa* L. (onion) as monocots and *Lepidium sativum* L. (cress), *Lactuca sativa* L. (lettuce), and *Lycopersicon esculentum* Will. (tomato) as dicots. This permitted us to elucidate their ecological role and to propose new herbicide models based on their structures. The best phytotoxicity results were shown by the degradation chemical 2-aminophenoxazin-3-one (APO) and several 2-deoxy derivatives of natural benzoxazinones, including 4-acetoxy-(2*H*)-1,4-benzoxazin-3(4*H*)-one (ABOA), 4-hydroxy-(2*H*)-1,4-benzoxazin-3(4*H*)-one (D-DIBOA), and 4-hydroxy-7-methoxy-(2*H*)-1,4-benzoxazin-3(4*H*)-one (D-DIMBOA). They showed high inhibitory activity over almost all species growth. The fact that APO is a degradation product from DIBOA with high phytotoxicity and stability makes it possible to assign an important ecological role regarding plant defense mechanisms. 2-Deoxy derivatives of natural benzoxazinones display a wide range of activities that allow proposing them as new leads for natural herbicide models with a 1,4-benzoxazine skeleton.

**KEYWORDS:** Allelochemicals, DIMBOA, DIBOA, soil degradation products, wheat, phytotoxicity, SAR, STS.

### INTRODUCTION

Benzoxazinones containing the hydroxamic acid moiety have attracted attention of phytochemistry researchers since the first isolation of 2,4-dihydroxy-(2*H*)-1,4-benzoxazin-3(4*H*)-one (DIBOA) (1) in 1959 and 2,4-dihydroxy-7-methoxy-(2*H*)-1,4-benzoxazin-3(4*H*)-one (DIMBOA) in 1962 (2) (Table 1, A). Interesting bioactivity was observed for both compounds, some of their degradation products, and also some synthetic analogues, being antimicrobial (3), antifeedant, insecticide (4), and phytotoxic behaviors (5, 6) widely described. The DIBOA natural glycoside (2-*O*- $\beta$ -D-glucopyranosyl-4-hydroxy-(2*H*)-1,4-benzoxazin-3(4*H*)-one (DIBOA-Glc) (Table 1, A) is the form in

which DIBOA is preserved inside the plant prior to its release (7). Benzoxazolin-2-one (BOA) and 6-methoxybenzoxazolin-2-one (MBOA) (Table 2, A) are the first chemicals in the DIBOA and DIMBOA degradation series, respectively (8–10). There are interesting precedents regarding their bioactivity on different systems. Lactam 2-hydroxy-(2*H*)-1,4-benzoxazin-3(4*H*)-one (HBOA) (Table 1, B) has been proposed as a biosynthetic precursor of DIBOA (11, 12). 2-Hydroxy-7-methoxy-(2*H*)-1,4-benzoxazin-3(4*H*)-one (HMBOA) (Table 1, B) has been detected as a degradation product for DIMBOA in wheat crop soil (9). Both compounds have been isolated from crop soils of plants with high production of benzoxazinones.

Antifeedant and antiaphid capabilities for DIMBOA and DIBOA, together with their related benzoxazolinones (Table 2, A) benzoxazinoid lactams (Table 1, B), and synthetic analogues (2-deoxybenzoxazinones, Table 1, C), were evaluated by Escobar et al. (4) on aphid *Sitobion avenae*. A complete

\* Author to whom correspondence should be addressed. Phone: +34-956.016.370. Fax: +34-956.016.193. E-mail: famacias@uca.es.

<sup>†</sup> Permanent address: Laboratorio de Química Ecológica, Departamento de Química, Facultad de Ciencias, Universidad de Los Andes, Núcleo Universitario Pedro Rincón Gutiérrez, La Hechicera, Mérida 5101-A, Venezuela.

**Table 1.** Natural Allelochemicals, Degradation Products/Biosynthetic Precursors, and Synthetic Analogs with Benzoxazinone Skeleton Employed for SAR Study<sup>a</sup>

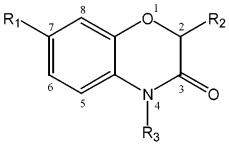
	
<b>Natural Allelochemicals</b>	<p><b>R<sub>1</sub>=H; R<sub>2</sub>=O-β-D-glucose; R<sub>3</sub>=OH:</b> 2-O-β-D-glycopyranosyl-4-hydroxy-(2<i>H</i>)-1,4-benzoxazin-3(4<i>H</i>)-one <b>DIBOA-Glc</b></p> <p><b>R<sub>1</sub>=H; R<sub>2</sub>=OH; R<sub>3</sub>=OH:</b> 2,4-dihydroxy-(2<i>H</i>)-1,4-benzoxazin-3(4<i>H</i>)-one <b>DIBOA</b></p> <p><b>R<sub>1</sub>=OCH<sub>3</sub>; R<sub>2</sub>=OH; R<sub>3</sub>=OH:</b> 2,4-dihydroxy-7-methoxy-(2<i>H</i>)-1,4-benzoxazin-3(4<i>H</i>)-one <b>DIMBOA</b></p>
<b>Degradation products/biosynthetic precursors</b>	<p><b>R<sub>1</sub>=H; R<sub>2</sub>=OH; R<sub>3</sub>=H:</b> 4-hydroxy-(2<i>H</i>)-1,4-benzoxazin-3(4<i>H</i>)-one <b>HBOA</b></p> <p><b>R<sub>1</sub>=OCH<sub>3</sub>; R<sub>2</sub>=OH; R<sub>3</sub>=H:</b> 2,4-dihydroxy-7-methoxy-(2<i>H</i>)-1,4-benzoxazin-3(4<i>H</i>)-one <b>HMBOA</b></p>
<b>Synthetic analogs</b>	<p><b>R<sub>1</sub>=H; R<sub>2</sub>=H; R<sub>3</sub>=H:</b> (2<i>H</i>)-1,4-benzoxazin-3(4<i>H</i>)-one <b>D-HBOA</b></p> <p><b>R<sub>1</sub>=OCH<sub>3</sub>; R<sub>2</sub>=H; R<sub>3</sub>=H:</b> 4-hydroxy-7-methoxy-(2<i>H</i>)-1,4-benzoxazin-3(4<i>H</i>)-one <b>D-HMBOA</b></p> <p><b>R<sub>1</sub>=H; R<sub>2</sub>=H; R<sub>3</sub>=OH:</b> 4-hydroxy-(2<i>H</i>)-1,4-benzoxazin-3(4<i>H</i>)-one <b>D-DIBOA</b></p> <p><b>R<sub>1</sub>=OCH<sub>3</sub>; R<sub>2</sub>=H; R<sub>3</sub>=OH:</b> 4-hydroxy-7-methoxy-(2<i>H</i>)-1,4-benzoxazin-3(4<i>H</i>)-one <b>D-DIMBOA</b></p> <p><b>R<sub>1</sub>=H; R<sub>2</sub>=H; R<sub>3</sub>=OAc:</b> 4-acetoxy-(2<i>H</i>)-1,4-benzoxazin-3(4<i>H</i>)-one <b>ABOA</b></p> <p><b>R<sub>1</sub>=OCH<sub>3</sub>; R<sub>2</sub>=H; R<sub>3</sub>=OAc:</b> 4-acetoxy-7-methoxy-(2<i>H</i>)-1,4-benzoxazin-3(4<i>H</i>)-one <b>AMBOA</b></p>

<sup>a</sup> Functionalization, systematic name, and acronym are shown for each compound.

structure–activity relationship (SAR) study was made. Compounds with a 1,4-benzoxazin-3-one skeleton (six-membered heterocyclic ring, **Table 1**) were more active as antifeedants than benzoxazolinones (five-membered heterocyclic rings, **Table 2, A**). Hydroxamic acids (hydroxyl group on the N-4 position) were much more active than their corresponding lactams (lack of hydroxyl group at N-4). The absence of a hydroxyl group at position C-2 (**Table 1, C**) strongly decreased the effect. A mortality test made on these organisms indicated DIMBOA and DIBOA to be the most toxic compounds. In general terms, an

electron-donor group at position C-7 (as it occurs in DIMBOA) increased the antifeedant index and the toxicity, and the presence of a hydroxyl group at positions C-2 and C-4 increased or decreased bioactivities depending on the aromatic substitution. Degradation processes from benzoxazinones to benzoxazolinones resulted in a partial detoxification.

Several authors evaluated phytotoxic activity of DIMBOA, DIBOA, and some related compounds (5, 6). Bravo and Lazo (13) provided interesting results regarding antialgal and antifungal activity by means of experiments with *Chlorella xanthella* and *Candida albicans*, respectively.

The alga *C. xanthella* has been proposed as a model for phytotoxicity evaluation. DIBOA showed more inhibitory activity than DIMBOA. The effect of 2-deoxy derivatives was different depending on the aromatic substitution since D-DIMBOA (**Table 1, C**) was more active than DIMBOA and D-DIBOA (**Table 1, C**) was less active than DIBOA. Lactam 2-hydroxy-(2*H*)-1,4-benzoxazin-3(4*H*)-one (HBOA) (**Table 1, B**) and the synthetic analogue 4-acetoxy-2*H*-1,4-benzoxazin-3(4*H*)-one (ABOA) (**Table 1, C**) showed very low phytotoxicities. The inhibition experiments on the fungus *C. albicans* allowed the authors to conclude that the 7-methoxy group increases fungistatic behavior and the presence of a hydroxyl moiety at C-2 also increases antifungal activity. The absence of this hydroxyl group blocks the opening of the heterocycle by means of hemiacetal hydrolysis on degradation processes (13) so it is possible to connect bioactivity with the keto form of the heterocyclic hemiacetal. Nevertheless, all the activity seemed to be controlled by the hydroxamic acid moiety. The authors did not provide comparisons with commercial herbicides or fungicides. Herein, we present a complete phytotoxicity profile of several synthetic derivatives with the lack of a hydroxyl at C-2 and the comparison of their bioactivity levels with those shown by natural allelochemicals DIMBOA and DIBOA.

Antimicrobial activity of DIMBOA and MBOA was evaluated and compared on *Agrobacterium tumefaciens* (14). DIMBOA showed higher toxicity, being the population development of this organism totally inhibited at  $5 \times 10^{-4}$  M (100% inhibition of colony diameter). Nevertheless, it was described as a bacteriostatic compound instead of a bactericide since it affected expression of *A. tumefaciens* virulence genes.

In general terms, natural 2,4-dihydroxybenzoxazin-3-ones (DIMBOA, DIBOA) (**Table 1, A**) are the most active compounds. Their corresponding benzoxazolinones (MBOA, BOA) (**Table 2, A**) are much less active, and 2-deoxy analogues of DIMBOA and DIBOA (**Table 1, C**) have different behaviors depending on the different species assayed. Lactams (**Table 1, B**) are nonactive compounds.

In addition to this bioactivity research, the low stability of DIMBOA, DIBOA, and their related benzoxazolinones in several conditions, such as biotransformation by fungi (15), and degradation in crop soil (16, 17) and in aqueous solution (8–10), has been investigated. We have recently developed a complete degradation study of these allelochemicals in wheat crop soil in which we observed and characterized the conversion dynamics of these compounds into several molecules carried out by soil microbial population (9, 10). 2-Aminophenoxazin-3-one (APO) and 2-amino-7-methoxyphenoxazin-3-one (AMPO) (**Table 2, B**) are the final products for the DIBOA and DIMBOA degradation route found by us in wheat crop soil. Several authors reported their presence in other systems in which these degradations take place (16, 17). Their *N*-acetyl derivatives, 2-acetamidophenoxazin-3-one (AAPO) and 2-acetamido-7-methoxyphenoxazin-3-one (AAMPO) (**Table 2, B**), have been proposed as detoxification compounds produced by nonpathogenic

**Table 2.** Base Structures, Functionalizations, Systematic Names, and Acronyms for the Degradation Products Employed for SAR Study

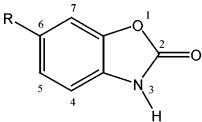
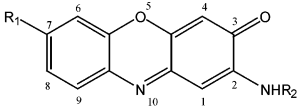
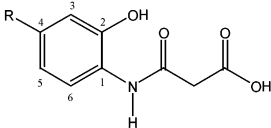
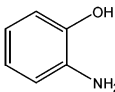
<b>A</b> <b>Benzoxazolinones</b>	<b>B</b> <b>Aminophenoxazines</b>	<b>C</b> <b>Malonamic acids</b>	<b>D</b> <b>Miscellaneous</b>
			
<p><b>R=H</b> Benzoxazolin-2(3<i>H</i>)-one <b>BOA</b></p> <p><b>R=OCH<sub>3</sub></b> 6-methoxybenzoxazolin-2(3<i>H</i>)-one <b>MBOA</b></p>	<p><b>R<sub>1</sub>=H; R<sub>2</sub>=H</b> 2-aminophenoxazin-3-one <b>APO</b></p> <p><b>R<sub>1</sub>=OCH<sub>3</sub>; R<sub>2</sub>=H</b> 2-amino-7-methoxyphenoxazin-3-one <b>AMPO</b></p> <p><b>R<sub>1</sub>=H; R<sub>2</sub>=OAc</b> 2-acetamidophenoxazin-3-one <b>AAPO</b></p> <p><b>R<sub>1</sub>=OCH<sub>3</sub>; R<sub>2</sub>=OAc</b> 2-acetamido-7-methoxy-phenoxazin-3-one <b>AAMPO</b></p> <p><b>R<sub>1</sub>=OH; R<sub>2</sub>=H</b> 2-amino-7-hydroxyphenoxazin-3-one <b>AHPO</b></p>	<p><b>R=H</b> N-[2-hydroxyphenyl]malonamic acid <b>HPMA</b></p> <p><b>R=OCH<sub>3</sub></b> N-[2-hydroxy-4-methoxyphenyl]malonamic acid <b>HMPMA</b></p>	<p>2-aminophenol <b>APH</b></p>

organisms associated to Gramineae (15, 18). APO has been already described as a potent phytotoxic agent for *Echinochloa crus-galli* (barnyardgrass) (16). This compound inhibited germination of this weed (50% inhibition at  $5 \times 10^{-4}$  M) more than its precursor 2-benzoxazolinone (BOA, 50% inhibition at  $0.7 \times 10^{-3}$  M). We present in this work a complete phytotoxicity profile for APO, its activity correlated with some analogue aminophenoxazines found in such degradation processes.

2-Hydroxyphenylmalonamic acids (Table 2, C) have been described as biotransformation products from benzoxazolinones, produced by endophytic fungi asymptotically associated to several cereal plants (15, 18, 19). *N*-[2-Hydroxyphenyl]-malonamic acid (HPMA) and *N*-[2-hydroxy-7-methoxyphenyl]-malonamic acid (HMPMA) have been tested over fungal colonies, and its influence over *Lepidium sativum* L. (cress) root length has been recorded, although comparison with commercial fungicides or herbicides was not made (18). Their activities have been compared with those for their precursors BOA and MBOA (Table 2, A). The lack of phytotoxicity observed for these malonamic acids allowed some researchers (18) to propose them as benzoxazolinone detoxification products. Herein, we present a complete phytotoxic bioactivity profile with three parameters (germination, root, and shoot lengths) and a wider variety of plant species.

Although many bioactivity data have been presented in the literature for benzoxazolinones and their degradation derivatives, the development of natural herbicide models based on their structures needs a complete study in which all compounds involved in plant defense and detoxification routes could be compared. This would also allow us to elucidate the different ecological roles of the degradation products. Then, a complete SAR study was designed on the basis of their phytotoxic bioactivities. Several nonnatural (2*H*)-1,4-benzoxazin-3(4*H*)-one

analogues were included in order to locate the required functionalization for phytotoxicity enhancement, with the purpose of new herbicide models development. Thus, all possible combinations regarding the presence or absence of hydroxyl groups at positions C-2 and N-4 and of a methoxy group at C-7 were tested (2-deoxy-4-hydroxy, 2-hydroxy-4-deoxy, 2,4-dihydroxy, and 2,4-dideoxy) for both series (7-methoxy- and 7-*H*-benzoxazolinones). 4-*N*-Acetoxy derivatives were also introduced to test the influence of a potential leaving group over N-4 (Table 1, C). A commercial herbicide is included as internal standard in order to control bioassay accuracy and to compare bioactivity levels with a real model.

Our objective in this study was to evaluate a complete phytotoxicity profile of these compounds considering effects on standard target species (STS) germination and growth (20). The results were correlated with compound structures. Degradation products (Table 2) (benzoxazolinones, aminophenoxazines, hydroxyphenylmalonamic acids) were included in order to evaluate their phytotoxic effect and to compare it with the chemicals from which they were transformed. This would allow us to establish their roles in Gramineae chemical defense. The relation between phytotoxic effect and soil persistence of degradation products investigated by us allowed the drawing of interesting conclusions about the ecological role of DIMBOA, DIBOA, and their main derivatives. All of these data will allow us to obtain an accurate scope of the allelopathic phenomena associated to benzoxazolinoids and their derivatives present in cultivars and to select which chemical structures would be useful to develop new herbicide models.

## MATERIALS AND METHODS

**General Methods.** The purity of the assayed compounds was determined by <sup>1</sup>NMR and HPLC analyses and was found to be >98%.

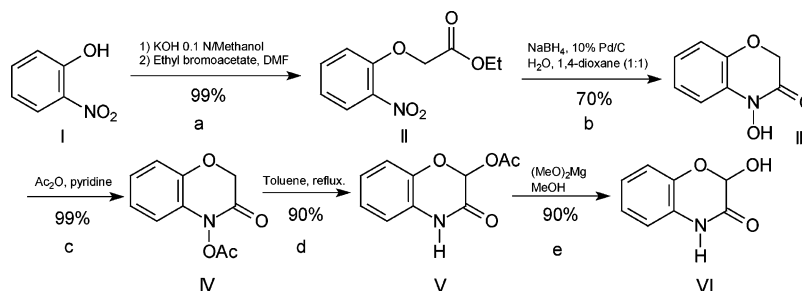
**Scheme 1.** Summary of Reactions and Conditions for the Synthesis of 2-Hydroxy-(2*H*)-1,4-benzoxazin-3(4*H*)-one (HBOA) from 2-Nitrophenol (I)

<sup>1</sup>H and <sup>13</sup>C NMR spectra were recorded using MeOH-*d*<sub>4</sub> as solvent in a Varian INOVA spectrometer at 399.99 and 100.577 MHz, respectively. Chemical shifts are given in ppm with respect to residual CH<sub>3</sub>OH or CD<sub>3</sub>OD signals ( $\delta = 3.30$  and 49.0, respectively). For HPLC analysis, an HPLC PDA detector (diode array UV-vis system), a column Phenomenex SYNERGI 4  $\mu$ m Fusion RP-80 (250 mm  $\times$  460 mm), and a Varian 1200L quadrupole MS/MS detector were used.

**Isolation and Synthesis of Natural Allelochemicals, Degradation Products, and Their Derivatives.** The studied chemicals belong to three different groups representing natural benzoxazinones, their degradation products, and several nonnatural analogues:

**Natural Benzoxazinones (Table 1, A).** DIBOA and DIMBOA were obtained from natural sources by means of previously reported isolation procedures (21, 22) modified by us. The DIBOA natural glycoside (2-O- $\beta$ -D-glucopyranosyl-4-hydroxy-(2*H*)-1,4-benzoxazin-3(4*H*)-one (DIBOA-Glc) was isolated from natural sources. Its isolation protocol, adapted from the literature, has been already described by us regarding its degradation study in wheat crop soil (10).

**Biosynthetic Precursors (Table 1, B) and Degradation Products (Table 2).** They have been selected according to the precedents mentioned above, belonging to four different structural types:

**Benzoxazolin-2-ones (Table 2, A).** Both of them are commercial compounds. They were purchased from Fluka Chemika and Lancaster Synthesis, respectively. They were used as received.

**Benzoxazinoid Lactams (Table 1, B).** They have been obtained at our laboratory by means of novel synthesis procedures in amounts enough to elucidate their phytotoxicity profiles. The synthetic route employed for HBOA is described in **Scheme 1**. The key to this method is an acyl [3.3] sigmatropic rearrangement from 4-acetoxy-(2*H*)-1,4-benzoxazin-3(4*H*)-one (ABOA, IV), which allowed functionalization at position C-2 (Step d). This reaction was previously described by Hashimoto et al. (23). Changing benzene for toluene as solvent allowed a higher reflux temperature, and reaction yield increased from the original 30% to 70%. The resulting acetyl ester at C-2 was selectively cleaved, searching for the preservation of the lactam moiety, by using magnesium methoxide in methanol at room temperature (Step e, 90% yield). This afforded the desired HBOA after five reaction steps with 55% yield. 4-Hydroxy-(2*H*)-1,4-benzoxazin-3(4*H*)-one (D-DIBOA, III) was obtained by adapting the method described by Atkinson et al. (24), in which THF in Step a was substituted with DMF in the search for a higher alkoxide solubility. Reductive cyclization (Step b) was also modified by changing the sodium borohydride proportion, so that the hydroxamic acid moiety was preferentially obtained instead of the lactam. A double proportion of reductive agent provided benzoxazinoid lactams in a selective manner. This procedure is general for all the 2-deoxy derivatives indicated below. DIMBOA analogues were obtained by changing starting material 2-nitrophenol by 5-methoxy-2-nitrophenol.

Nevertheless, this procedure was not valid for HMBOA (**Table 1, B**) synthesis since acyl sigmatropic rearrangement was not successful. Thus, a hemisynthesis from natural DIMBOA was optimized with just one reaction step (**Scheme 2**). The N-OH moiety of natural DIMBOA was reduced to N-H by employing samarium diiodide, a reagent described for selective reduction of oximes, hydroxylamines, and hydroxamic acids (25), which has never been employed in this kind of compounds.

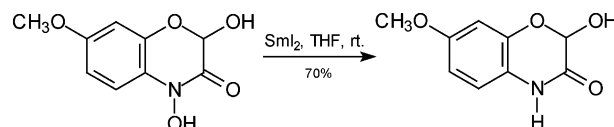
**Scheme 2.** 2-Hydroxy-7-methoxy-(2*H*)-1,4-benzoxazin-3(4*H*)-one (HMBOA) Was Obtained from DIMBOA after Reduction with Samarium Diiodide

Hydroxyphenylmalonic Acids (**Table 2, C**). They have been synthesized in our laboratory (**Scheme 3**) by employing a modification from a previously reported procedure (18). Although this reported method leads directly to both compounds, we wanted to modify it in the search with the main objective of controlling protection and deprotection of both phenolic and ammine moiety, so that we could access to modified 2-aminophenol with selectivity. We also wanted to avoid aminophenol dimerization, which would lead to aminophenoxazines, as commented below. Thus, we got access to *tert*-butyldimethylsilyloxyanilines (both 5-methoxy and 5-*H*), and after catalytic hydrogenation, amidation and basic hydrolysis, both malonic acids were obtained in high yield (68%).

**Aminophenoxazin-3-ones (Table 2, B).** APO and AAPO have been synthesized in large scale by using previously reported procedures (16). 2-Amino-7-methoxyphenoxazin-3-one (AMPO) and 2-acetamido-7-methoxyphenoxazin-3-one (AAMPO) were obtained in our laboratory by novel synthesis methods (**Scheme 4**). In the search for 5-methoxy-2-aminophenol, we proceeded with the reduction of the corresponding nitro derivative 5-methoxy-2-nitrophenol, employing conditions similar to those shown for reductive cyclization mentioned above which are compatible with that reduction. Otherwise, 70% yield of the dimer AMPO was obtained. Further amine acylation yielded AAMPO. The investigation of the Pd catalyst role in the dimerization process is one of our current efforts regarding aminophenoxazines chemistry.

**Nonnatural 1,4-Benzoxazin-3-one Analogues (Table 1, C).** Six synthetic analogues with a 1,4-benzoxazin-3-one skeleton have been included in the study with the main purpose of studying the influence of hydroxyl groups at positions C-2 and N-4 of benzoxazinones with hydroxamic acid moiety and benzoxazinoid lactams: D-DIBOA, 4-hydroxy-7-methoxy-(2*H*)-1,4-benzoxazin-3(4*H*)-one (D-DIMBOA), (2*H*)-1,4-benzoxazin-3(4*H*)-one (D-HBOA) and 7-methoxy-(2*H*)-1,4-benzoxazin-3(4*H*)-one (D-HMBOA). ABOA and 4-acetoxy-7-methoxy-(2*H*)-1,4-benzoxazin-3(4*H*)-one (AMBOA) have been included to study the influence of an N-OH blockage in the bioactivity. The lack of hydroxyl group at position C-2 is common for all these derivatives due to its presence in natural benzoxazinones being directly associated to the proposed degradation processes mechanisms (24). Thus, these compounds are stable models for the 1,4-benzoxazin skeleton. They have been obtained by synthetic methods adapted from the literature as commented above. The changing of the reductive agent-starting material ratio afforded either hydroxamic acids or lactams at N-4 at the reductive cyclization step (**Scheme 1**, Step b) (1:1 and 1:2, respectively).

**Additional Compounds Evaluated.** To characterize its bioactivity and to discuss the phytotoxicity of DIBOA degradation route chemicals, 2-aminophenol (**Table 2, D**) (purchased from Sigma-Aldrich, used as received) was evaluated. 2-Amino-7-hydroxyphenoxazin-3-one (AHPO) (**Table 2, B**) was included in the study of the activity-lipophilicity

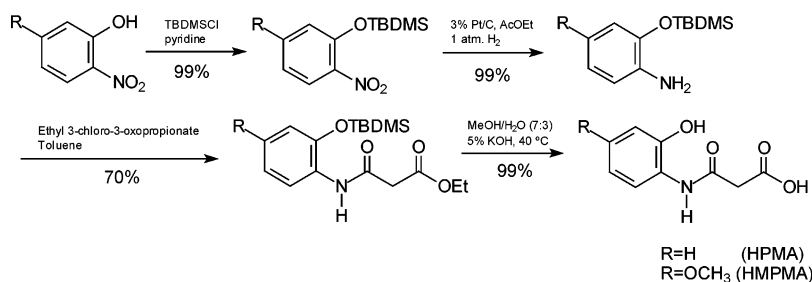
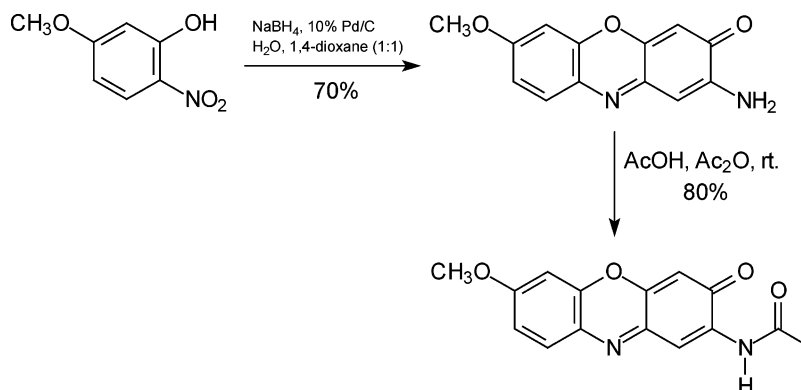
**Scheme 3.** Summary of Reactions and Conditions for the Synthesis of Hydroxyphenylmalonic Acids HPMA and HMPMA**Scheme 4.** Summary of Reactions and Conditions for the Synthesis of 7-Methoxyphenoxazines from 5-Methoxy-2-nitrophenol

relationships for aminophenoxazines described below. It was obtained from AMPO by demethylation with hydrobromic acid at 100 °C (99% yield), and its phytotoxicity was evaluated.

**Phytotoxic Activity Bioassay.** *Target Plants.* Selection of target plants is based on an optimization process made by us in the search for a standard phytotoxicity evaluation bioassay (20). After this process, several STS were proposed, including monocots *Triticum aestivum* L. (wheat) and *Allium cepa* L. (onion) and dicots *Lycopersicon esculentum* Will. (tomato), *Lepidium sativum* L. (cress) and *Lactuca sativa* L. (lettuce), which were assayed for this study.

*Methodology.* Bioassays used Petri dishes (90 mm diameter) with one sheet of Whatman No.1 filter paper as support. Germination and growth were conducted in aqueous solutions at controlled pH by using  $10^{-2}$  M 2-[N-morpholino]ethanesulfonic acid (MES) and NaOH 1 M (pH = 6.0). Solutions (0.2, 0.1, 0.02, 0.01, and 0.002 M) of the compounds to be assayed were prepared in DMSO and then diluted with buffer (5  $\mu$ L DMSO/mL buffer) to reach the test concentrations for each compound ( $10^{-3}$ ,  $5 \times 10^{-4}$ ,  $10^{-4}$ ,  $5 \times 10^{-5}$ , and  $10^{-5}$  M). This procedure facilitated the solubility of the assayed compounds. The number of seeds in each Petri dish depended on the seed size. Twenty five seeds were used for tomato, lettuce, cress, and onion and 10 seeds were used for wheat. Five milliliters of treatment, control, or internal reference solution were added to each Petri dish. Four replicates were used for tomato, cress, onion, and lettuce (100 seeds); 10 replicates (100 seeds) were used for wheat.

After adding seeds and aqueous solutions, Petri dishes were sealed with Parafilm to ensure closed-system models. Seeds were further incubated at 25 °C in a Memmert ICE 700 controlled-environment growth chamber in the absence of light. Bioassays took 4 days for cress, 5 days for lettuce, tomato, and wheat, and 7 days for onion. After growth, plants were frozen at -10 °C for 24 h to avoid subsequent growth during the measurement process. This helped the handling of the plants and allowed a more accurate measurement of root and shoot lengths.

The commercial herbicide Logran, a combination of *N*-(1,1-dimethylethyl)-*N'*-ethyl-6-(methylthio)-1,3,5-triazine-2,4-diamine (Terbutryn, 59.4%) and 2-(2-chloroethoxy)-*N*-[[4-methoxy-6-methyl-1,3,5-triazin-2-yl]amino]carbonyl]benzenesulfonamide (Triasulfuron, 0.6%) was used as internal reference, according to a comparison study previously reported (20). It was used at the same concentrations ( $10^{-3}$ ,  $5 \times 10^{-4}$ ,  $10^{-4}$ ,  $5 \times 10^{-5}$ , and  $10^{-5}$  M) and in the same conditions as

the compounds in study. Control samples (buffered aqueous solutions with DMSO and without any tested compound) were used for all the plant species assayed.

*Bioassay Data Acquisition.* Evaluated parameters (germination rate, root length, and shoot length) were recorded by using a Fitomed system (26) that allowed automatic data acquisition and statistical analysis by its associated software.

*Statistical Analysis.* Data were statistically analyzed using Welch's test, with significance fixed at 0.01 and 0.05. They are presented as percentage differences from control. Zero represents control, positive values represent stimulation of the studied parameter, and negative values represent inhibition (20, 26).

Once the germination and growth data are acquired, cluster analysis was used to group compounds with similar phytotoxicity behaviors and associate them with their molecular structure. Complete linkage was used as amalgamation rule and the distance measurement was based on squared euclidean distances (27), given by this equation:

$$d(x,y) = \sum_i (x_i - y_i)^2$$

Where  $d(x,y)$  is the squared euclidean distance ( $i$ -dimensional),  $i$  represents the number of variables, and  $x$  and  $y$  the observed values.

The cluster was obtained by using Statistica v. 5.0 software. The lack of consistent effects over germination for almost all assayed species forced us to make cluster analysis on the basis of growth parameters (root length and shoot length). Results for all STS, except lettuce, which did not show good correspondence between concentration and phytotoxic effect in some cases, were included in order to acquire an overall view of the phytotoxicity and its relation with chemical structure.

EC50 values were obtained after adjusting phytotoxicity data to concentration (logarithmic scale), to a sigmoidal dose-response curve, defined by the equation:

$$Y = Y_{\min} + \frac{Y_{\max} - Y_{\min}}{1 + 10^{\log EC50 - X}}$$

Where  $X$  indicates the logarithm of the concentration,  $Y$  indicates the response (phytotoxicity), and  $Y_{\max}$  and  $Y_{\min}$  are the maximum and minimum values of the response, respectively. Goodness of fit is

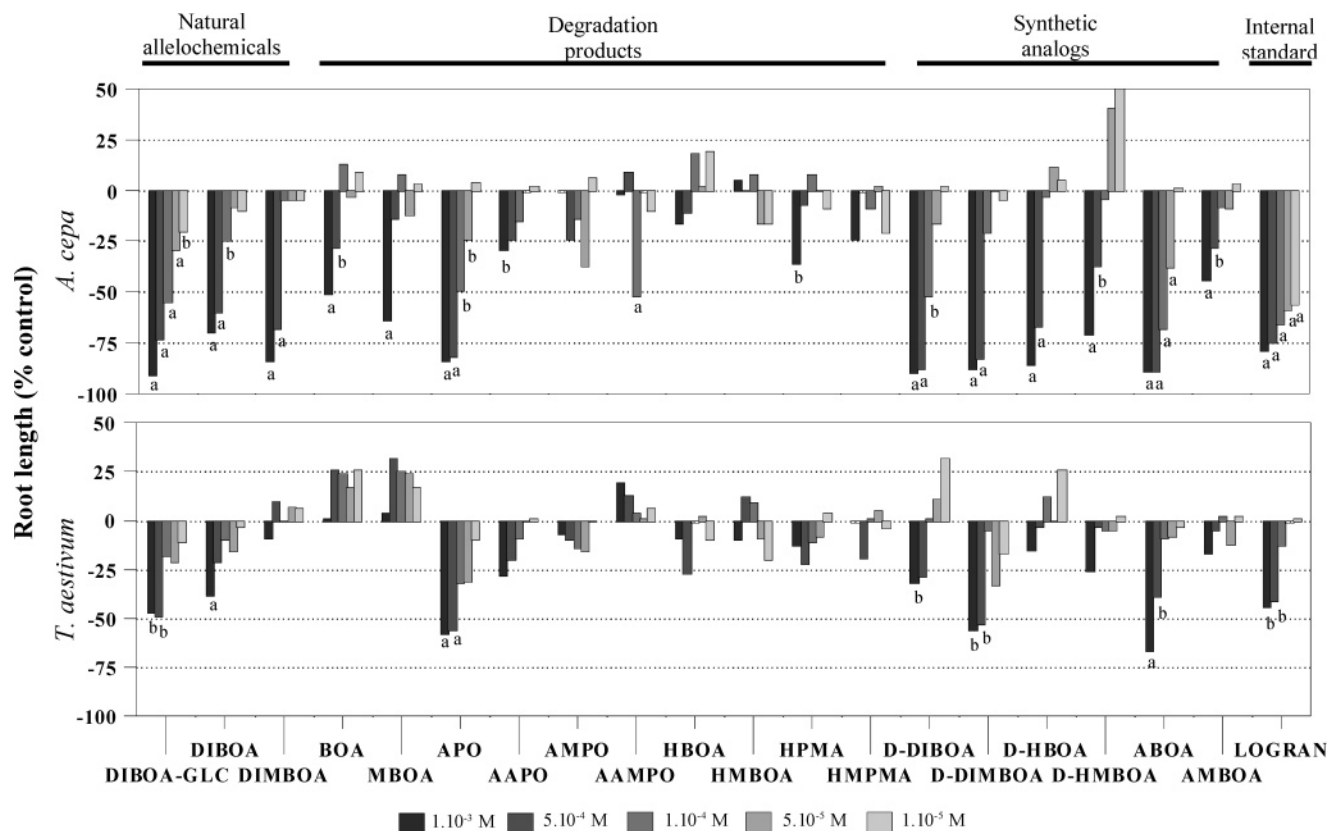

**Figure 1.** Phytotoxicity bioassay results (root length, % from control) for monocot species (*Allium cepa* L. and *Triticum aestivum* L.). If it is not indicated,  $P > 0.05$  for Welch's test. (a) Values significantly differ with  $P < 0.01$ . (b) Values significantly differ with  $0.01 < P < 0.05$ .

described by determination coefficient ( $r^2$ ). The adjustment and the  $r^2$  were obtained by using GraphPad Prism software v. 4.00.

**Lipophilicity Calculations.** Lipophilicity, expressed as  $\log P$  (water/*n*-octanol partition coefficient) value, was obtained by computational methods according to the Ghose, Prichett, and Crippen methodology (28). This algorithm is implemented in Hyperchem v. 7.0 software.

## RESULTS AND DISCUSSION

**Phytotoxic Bioactivity Profiles.** Effects of the assayed compounds on monocots (root length) are shown in **Figure 1**. The same parameter for cress and tomato is shown in **Figure 2**. The most affected parameter was root length for all the active compounds, followed by shoot length. Effects over *Lactuca sativa* L. were diverse, but a good correspondence between concentration and effect was not observed. Thus, lettuce growth results were not included in the cluster analysis.

All chemicals showed inhibitory profiles, except AMPO and its acetate AAMPO (**Table 2, B**) in cress and lettuce and BOA and MBOA (**Table 2, A**) for wheat, although these effects are not very consistent. Natural allelochemicals and their synthetic analogues were the most active compound groups. The rest of the analyzed chemicals, which are present in natural benzoxazinone degradation routes, had moderate or null activity, except APO (**Table 2, B**), which showed the highest inhibitory effects of the degradation products.

The presence of wheat in the bioassay is especially valuable since this would allow for discovering autotoxicity phenomenon associated to these wheat allelochemicals and their potential utility to weed management for wheat and analogous crops. All assayed species were highly affected by the most active chemicals, except wheat, which was moderately inhibited. This selective behavior, specially observed for DIMBOA allows us to conclude that this natural allelochemical, together with its

degradation products, is not involved in intraspecific competition phenomena for wheat. DIBOA-Glc and DIBOA moderately affected wheat. Although these compounds and APO inhibited wheat growth, the concentrations assayed here are significantly higher than the natural ones according to several estimation previously discussed by us (9). Their synthetic analogues did not affect wheat germination or growth, especially at the lowest concentrations, so the chemicals belonging to this series could be good candidates for the development of new herbicide models for wheat weed control. A similar structure–activity relationships study for common wheat weeds (i.e., *Lolium rigidum* L. and *Avena fatua* L.) is needed to confirm this hypothesis, and it is currently taking place in our laboratory.

**Benzoxazinones.** DIBOA and its glycoside showed similar inhibition profiles. *Allium cepa* was the most affected plant according to inhibition recorded at high and at low doses (70% and 91% inhibition for root length at  $10^{-3}$  M, respectively). These compounds maintained phytotoxicity at  $5 \times 10^{-4}$  M for this plant (60% and 73% inhibition for root length at for DIBOA and DIBOA-Glc respectively). DIBOA phytotoxic activity is higher over roots than over shoots, and there is lower activity over monocotyledonous that even disappear when the target species is wheat. This fact clearly showed a lack of autotoxicity for this compound. Regarding DIMBOA bioactivity, significant inhibition levels were recorded for root lengths in all assayed species, except wheat and lettuce (*A. cepa*: 68%; *L. esculentum*: 86%; *L. sativum*: 74% at  $5 \times 10^{-4}$  M).

**Benzoxazinoid Synthetic Analogues.** The effects shown by these compounds were highly inhibitory in the cases of *L. sativum*, *L. esculentum*, and *A. cepa*. DIBOA-related compounds (D-DIBOA, D-HBOA, and especially ABOA) (**Table 1, C**) showed the highest inhibition levels, and the effects were significantly preserved at  $10^{-4}$  M for D-DIBOA and ABOA

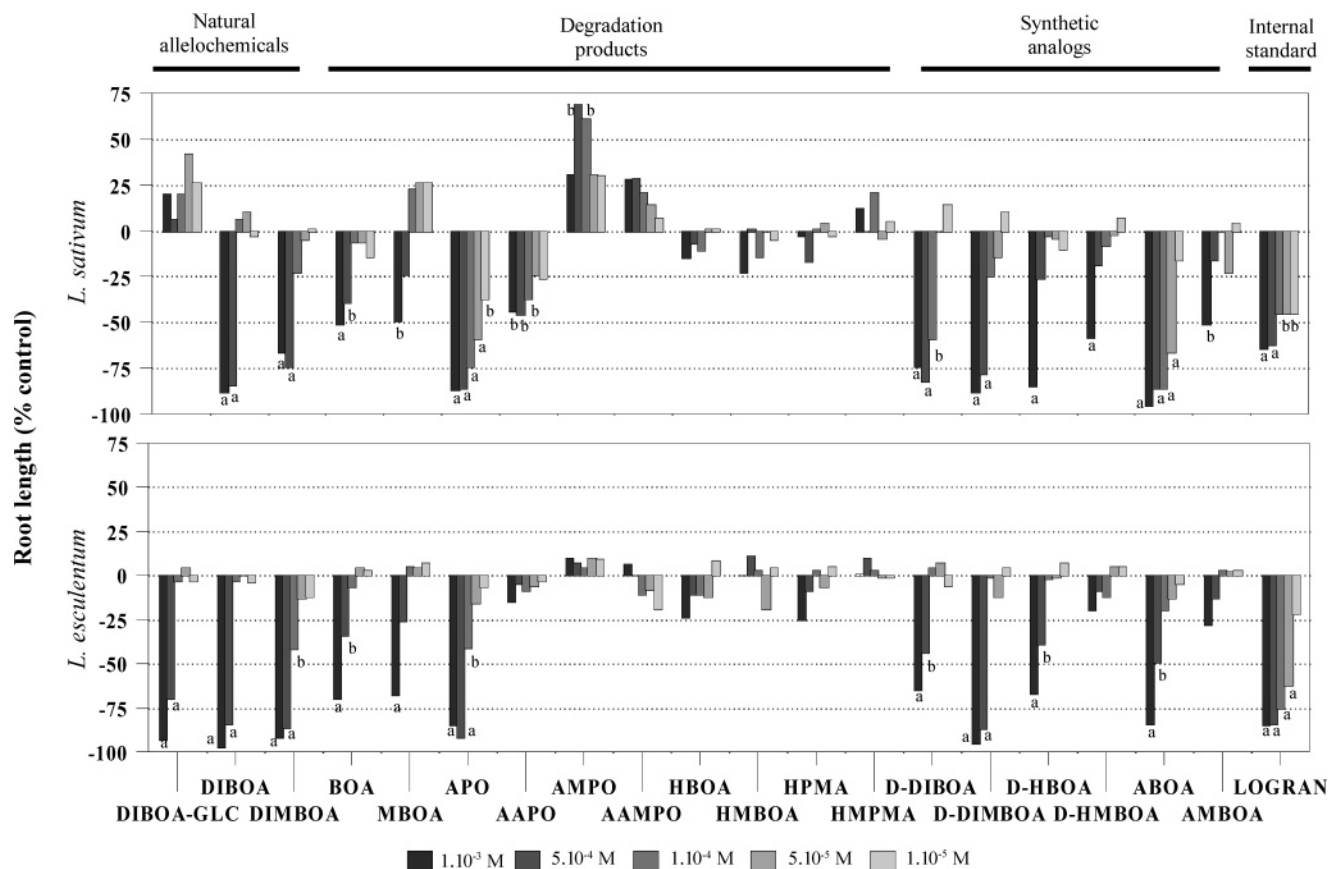

**Figure 2.** Phytotoxicity bioassay results (root length, % from control) for dicot species (*L. sativum* L. and *L. esculentum* Will.). If it is not indicated,  $P > 0.05$  for Welch's test. (a) Values significantly differ with  $P < 0.01$ . (b) Values significantly differ with  $0.01 < P < 0.05$ .

(52%, 68%–*A. cepa*, root length). Almost complete inhibition effects were recorded at higher concentrations (D-DIBOA, 90%; D-HBOA, 86%; ABOA, 89%, *A. cepa*, root length,  $10^{-3}$  M). The *N*-acetyl derivative of D-DIBOA (ABOA) showed the most important effect at low concentrations, as it can be observed for *A. cepa* and *L. sativum* root growth inhibition from  $10^{-3}$  to  $10^{-4}$  M. This product also presented interesting shoot inhibition for *L. esculentum*, *L. sativa*, *A. cepa*, and *L. sativum*. D-HBOA presented null effects at highly diluted treatments.

**Degradation Products.** The bioactivity observed for natural benzoxazinones was not preserved for their degradation products. Benzoxazolinones BOA and MBOA were slightly inhibitory at the highest concentration toward lettuce (root growth, 39%, 20%), and significant inhibition values were also observed for onion (51%, 64%), tomato (70%, 68%), and cress (51%, 49%) roots at  $10^{-3}$  M. All these effects were lost at any lower concentrations. As in the case of DIBOA and DIMBOA, their phytotoxic activity is higher over roots than over shoots, in which the inhibitory effect over monocotyledonous species was not shown. This fact agrees with other studies carried out in lettuce about the mode of action of BOA (29). It is possible that this compound causes an integrity disruption at a radicular cell membrane system. When the target species is wheat, there are even promoting effects.

Benzoxazinoid lactams (HBOA, HMBOA) (Table 1, B) and malonic acids (HPMA, HMPMA) (Table 2, C) were not significantly active in any case. HBOA has been proposed as an intermediate in DIBOA biosynthesis, and its lack of phytotoxic effect agrees with the idea that the 4-hydroxy group of benzoxazinoids is crucial for the biological activity. HMBOA is not a precursor for DIMBOA synthesis, as it would be expected by its structure (30). It has been detected in wheat

crop soil degradation experiments carried out with DIMBOA (9), and its phytotoxicity profile allows this compound to be proposed as a detoxification metabolite. AAPO and AAMPO (Table 2, B) showed some effect, but they were not significant in comparison to the rest of the bioassay. This is in good agreement with their detoxification role proposed in the literature (31).

In contrast to these results, aminophenoxazine APO showed strong inhibition profiles for root and shoot lengths of all assayed species except wheat in which it had moderate effect over root length and lettuce in which germination rate was the most affected parameter (76% at  $10^{-3}$  M and 78% at  $10^{-4}$  M) and growth was moderately inhibited (~50% at  $10^{-3}$  M). Effects over tomato ( $EC_{50} = 153 \mu\text{M}$ ,  $r^2 = 0.95$ ), onion ( $EC_{50} = 72.9 \mu\text{M}$ ,  $r^2 = 0.99$ ), and cress ( $EC_{50} = 38.2 \mu\text{M}$ ,  $r^2 = 0.99$ ) roots are especially significant. There was also high inhibition in shoot length for these three species.

**Structure–Activity Relationships.** Cluster analysis for growth results in STS for all compounds is shown in Figure 3. Activities can be divided in two main groups (G1 for high and moderate activities and G2 for low effects). G1 is divided into two subgroups (G1A for the highest effects and G1B for moderate inhibitions).

The most active group (G1A) is formed by the commercial herbicide Logran, aminophenoxazin APO (Table 2, B), three 2-deoxy derivatives (ABOA, D-DIBOA, and D-DIMBOA) (Table 1, C), and natural benzoxazinones DIBOA and DIMBOA (Table 1, A). Moderate activity levels were recorded for acetamidophenoxazin AAPO (Table 2, B) benzoxazolinones (Table 2, A), DIBOA-Glc (Table 1, A), 2-deoxy lactams (D-HBOA and D-HMBOA), and ABOA (Table 1, C). The lower effects were observed for malonic acids HPMA and HMPMA

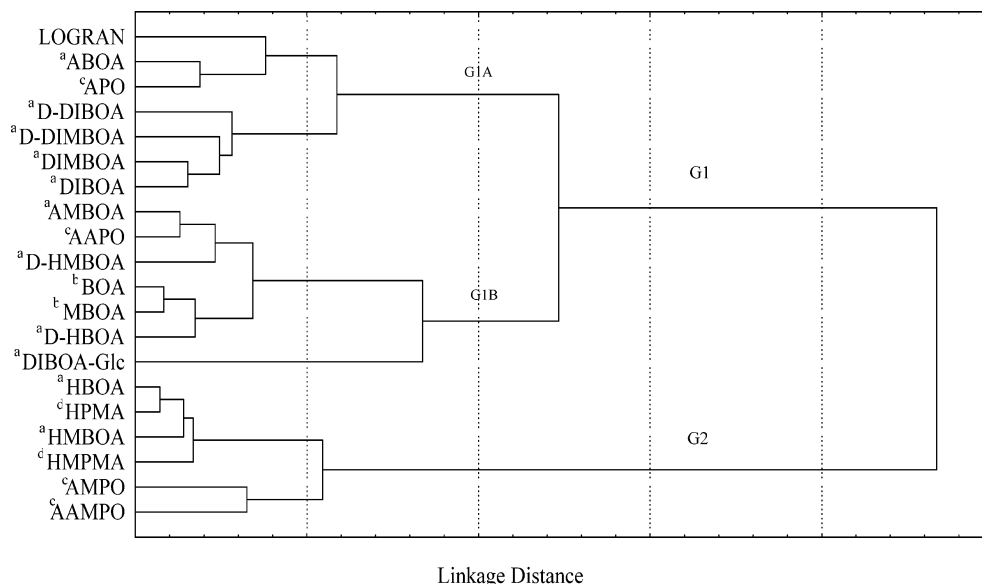

**Figure 3.** Cluster analysis for STS growth inhibition (effects on root length and shoot length); (a) benzoxazinones; (b) benzoxazolinones; (c) aminophenoxazines; and (d) malonic acids.

(Table 2, C), lactams HBOA and HMBOA (Table 1, B), and 7-methoxyphenoxazines AMPO and AAMPO (Table 2, B).

**Benzoxazines.** The synthetic benzoxazines (Table 1, C) have been selected to study the influence of the different functional group combinations at C-7, C-2, and N-4. The 7-methoxybenzoxazines can be structurally correlated with DIMBOA and HMBOA, while the lack of functional group at C-7 corresponds to the DIBOA and HBOA series. Both of these groups have compounds with the 2-hydroxy moiety (D-HMBOA and D-HBOA, respectively), 4-hydroxy (D-DIMBOA and D-DIBOA), and 2-acetoxy (AMBOA and ABOA). Their activities can be correlated with the ones observed for the natural products DIMBOA and DIBOA, together with their benzoxazolinones MBOA and BOA (Table 2, A).

DIMBOA and DIBOA have low activities, especially in wheat, lettuce, and cress. There is no evidence about the degradation of 2-deoxy derivatives of benzoxazinones in any conditions, while DIMBOA and DIBOA are degraded to their benzoxazolinones. Their first degradation products, BOA and MBOA, have activities much lower than them. 2-Deoxy derivatives are stable through all the assay time, while DIMBOA and DIBOA are degraded to their benzoxazolinones (31).

D-DIMBOA and D-DIBOA have very similar effects, and they could be candidates for further development of herbicide models based on the 1,4-benzoxazine skeleton. Different functional groups at N-4 have to be assayed for bioactivity enhancement, as ABOA results suggest. The observed phytotoxicity values lead to structural modifications at DIBOA derivatives in the search for the most inhibitory compounds. This fact will lead us to a more detailed study of 2-deoxy derivatives and their properties and biological effects. The lack of a hydroxyl group at position 2 enhances bioactivity. It can be also observed by comparing 2-hydroxy lactams (HBOA and HMBOA, with low or null activities) and their 2-deoxy analogues (D-HBOA and D-HMBOA, with moderate inhibition levels).

The high bioactivity levels shown by the *N*-acetoxy derivative of D-DIBOA (ABOA) could lead future research in 4-hydroxy-1,4-benzoxazin structure modification. Some authors have suggested the presence of this acetyl leaving group at the N-4 position to enhance toxicity of these 2-deoxy benzoxazinones, acting as leaving group and provoking the formation of a highly

stabilized electrophilic intermediate (23), but the low phytotoxicity results obtained for the *N*-4-acetoxy derivative of D-DIMBOA (AMBOA) suggests the opposite statement. This modification does not enhance phytotoxicity at 7-methoxybenzoxazinones.

**Aminophenoxazines.** 2-Aminophenoxazin-3-one (APO) is the only aminophenoxazin belonging to G1A group (Figure 3). Its acetate (AAPO) has moderate activity (G1B) and 7-methoxyphenoxazines AMPO and AAMPO are the least active compounds of the whole assay.

Previous works about the occurrence of aminophenoxazin skeleton (Table 2, B) in the degradation processes of natural benzoxazinones suggest acetamidophenoxazines to be detoxification products of the amines APO and AMPO (31). This hypothesis can be accepted in the case of APO and AAPO due to the lack of activity observed for the last one. Phytotoxicity for AMPO is much lower than expected in comparison to its nonmethoxylated analogue APO. Taking into account the similarity of APO and AMPO structures, their big differences in activity could be due to other phenomena, like aqueous and lipid solubility and their consequences regarding chemicals' diffusion through the cell membrane.

According to Lipinskii (32) and Tice (33) models for bioactivity in pharmaceuticals and agrochemicals, the solubility in lipids or aqueous media is a very important parameter in the search for bioactive compounds. These solubilities can be quantified by using  $\log P$  (water/*n*-octanol partition coefficient). Previous studies performed by us regarding bioactivity of sesquiterpene lactones allowed us to establish correlations between  $\log P$  and  $EC_{50}$  for several bioactivity parameters. Thus,  $\log P$  was theoretically calculated for all assayed aminophenoxazines (Table 2, B) by computational methods (28). To add another analogous compound, phytotoxicity of 7-hydroxy-2-aminophenoxazin-3-one (AHPO) was evaluated for *L. esculentum*. A correlation between phytotoxicity values (root length of *Lycopersicon esculentum*) and  $\log P$  can be observed in Figure 4. When  $\log P > 0.6$ , a significant activity value can be observed. For lower  $\log P$ , effects are constrained between +20 and -20%, which constitutes a drastic phytotoxicity loss. In addition to this, we have observed precipitation for APO solutions at concentrations higher than  $5 \times 10^{-4}$  M. This would



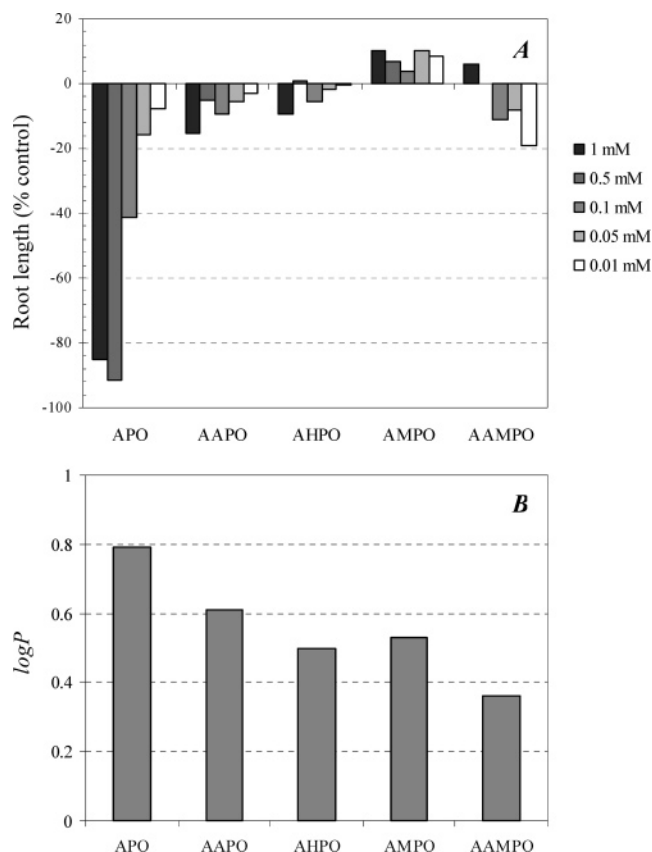
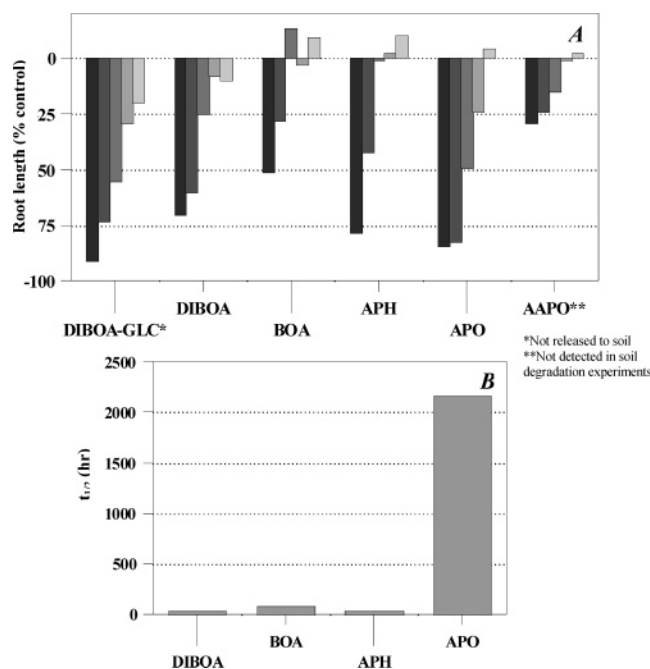

**Figure 4.** Phytotoxicity (*Lycopersicon esculentum* Will., root length) (A) and lipophilicity (log *P*) (B) for aminophenoxazines.

explain the similarity observed for phytotoxic activities at the two higher concentrations for almost all tested bioactivity parameters.

**Ecological Role of Benzoxazinones and Degradation Products.** DIBOA-Glc, DIBOA, BOA, APO, and AAPO, together with 2-aminophenol (APH) constitute a complete degradation series carried out by soil microbes, as well as by other organisms (31). DIBOA-Glc is produced by the plant and liberated as the aglucon DIBOA, which participates in the different degradation processes (7, 9, 10). Thus, it is interesting to compare bioactivity values for the complete series since all these compounds are together in soil while the degradation process takes place. This comparison would lead us to describe the role that soil microbes could play in the chemical defense strategies employed by plants with high production of benzoxazinones. The half-lives of compounds were obtained by means of the wheat crop soil degradation study mentioned above (10).

The phytotoxicity values, expressed as root growth inhibition for *Allium cepa* and the half-life values observed for each compound (except for DIBOA-Glc, which is not released to soil, and AAPO, which was not detected in our degradation experiments) are shown in **Figure 5**. The high persistence in soil shown by APO, much higher than its precursors, in addition to its high phytotoxicity, leads us to assign a critical role regarding chemicals defense in DIBOA producer plants, other than DIBOA or BOA, that have been proposed as the main responsible for several plant–plant interaction phenomena (6, 34, 35). The occurrence of degradation in buffered aqueous solution (8, 10) also enforces a careful revision of the bioassay methodologies employed in the phytotoxicity evaluation of 2,4-dihydroxybenzoxazinones and benzoxazinones since the activities observed could be due to degradation products instead of the original materials dosed.



**Figure 5.** Phytotoxicity (*Allium cepa* L., root length) and persistence in soil (half-life) for DIBOA degradation series compounds in wheat crop soil.

**Conclusions.** Regarding new herbicide model development, benzoxazinones constitute the most interesting group since they are afforded by high-yield and easy-to-scale synthetic methods. In addition to this, their molecular structure and functionalization permits different modifications at the heterocycle and the aromatic ring, so a large number of candidates could be developed and tested in further research about this matter.

The bioactivity profiles shown by benzoxazinones suggest 2-deoxy derivatives of natural allelochemicals DIBOA and DIMBOA (D-DIMBOA and D-DIBOA) (Table 1, C) to be the best leads for new herbicides with this structural base. D-DIBOA matches all the conditions that increase phytotoxicity on the species assayed: lack of hydroxyl group at C-2, hydroxyl at N-4, and absence of a methoxy group in the aromatic ring. The fact that acetylation of the hydroxyl group at position N-4 increases phytotoxicity of this compound's analogues, points to an interesting direction regarding further chemical modifications of this structure with the purpose of phytotoxicity enhancement. The N–OH moiety can constitute the base of a more accurate adequation of this benzoxazinones to the Lipinskii (32) and Tice (33) rules mentioned above. The introduction of longer side chains via esterification or etherification could increase molecular weight, as well as lipophilicity. The lower phytotoxicity levels shown by 2,4-dihydroxy compounds (DIMBOA and DIBOA) in some cases could be due to degradation phenomena leading to less active compounds such as BOA or MBOA, which are much more stable. A degradation study for these compounds in the buffer employed in these bioassays will allow us to elucidate the role of degradation processes in DIBOA and DIMBOA bioactivity evaluation.

Aminophenoxazin APO was the most active degradation compound, with high phytotoxicity levels and also high maintenance of the effect at low concentrations. The lack of phytotoxic effect observed for its structurally related compounds, such as AMPO and AHPO, could be related to their lipophilia. The effects observed for acetamidophenoxazines AAPO and AAMPO confirm them as detoxification derivatives. Their bioactivity values are in good accordance with the correlation

with lipophilia expressed above. The high persistence of this compound in wheat crop soil recorded by us (10) makes this compound a weak candidate for new herbicide models development at least at this research stage. Further research will be needed to discover its utility in pest management. Taking into consideration reports from the literature (31) describing degradation for aminophenoxazines, which proceeds with detoxification, as phytotoxicity for AAPO and AAMPO data show, further research is needed to determine the final fate of aminophenoxazines in soil and other environments. Antifungal activity shown by APO (31) could affect its own degradation dynamics in soil, at least at the higher dosed employed in its degradation experiments (10).

Nevertheless, APO showed high phytotoxicity and also higher persistence in soil than its precursors BOA and DIBOA. These facts allow us to conclude that some of the allelopathic behaviors observed in plants that produce DIBOA could be due to its degradation compound rather than the compound originally released by plant. The low phytotoxicity of AMPO points to the opposite direction regarding the DIMBOA series, so a more accurate study about its interaction with soil biological population and inorganic materials will be needed to discover its ecological role. This fact, in addition to the higher persistence in soil shown by DIBOA degradation series compounds (10), allows us to conclude that DIBOA producing species take more advantage of allelopathic defense strategies based on benzoxazinones than DIMBOA producing ones.

The many different bioactivities shown by degradation products of DIBOA and DIMBOA have to be taken into account in the research of their biological activities and mode of action since the effects observed could be related to the presence of such derivatives in stock solutions and standards employed for these evaluations, especially in the longer time experiments.

Our current efforts are directed toward the evaluation of these compounds over common wheat weeds and other target organisms.

#### ACKNOWLEDGMENT

This work was financially supported by the program 'Quality of life and management of living resources (1998 to 2002)' of the European Union, FATEALLCHEM Contract No. QLRT-2000-01967. Fellowships from Universidad de los Andes-Venezuela (A. O. B.), European Commission (European Union), and Junta de Andalucía-Spain (D. M.) are also gratefully acknowledged.

#### LITERATURE CITED

- (1) Virtanen, A. I.; Hietala, P. K. The structures of the precursors of benzoxazolinone in rye plants. II. *Suom. Kemistil. B* **1959**, *32B*, 252.
- (2) Hamilton, R. H.; Bandurski, R. S.; Reusch, W. H. Isolation and characterization of a cyclic hydroxamate from *Zea mays*. *Cereal Chem.* **1962**, *39*, 107–113.
- (3) Honkanen, E.; Virtanen, A. I. Synthesis of some 1,4-benzoxazine derivatives and their antimicrobial activity. *Acta Chem. Scand.* **1960**, *14*, 1214–1217.
- (4) Escobar, C. A.; Sicker, D.; Niemeyer, H. M. Evaluation of DIMBOA analogues as antifeedants and antibiotics towards the aphid *Sitobion avenae* in artificial diets. *J. Chem. Ecol.* **1999**, *25*, 1543–1554.
- (5) Schulz, M.; Friebe, A.; Kueck, P.; Seipel, M.; Schnabl, H. Allelopathic effects of living quack grass (*Agropyron repens* L.). Identification of inhibitory allelochemicals exuded from rhizome borne roots. *Angew. Bot.* **1994**, *68*, 195–200.
- (6) Wolf, R. B.; Spencer, G. F.; Plattner, R. D. Benzoxazolinone, 2,4-dihydroxy-1,4-benzoxazin-3-one, and its glucoside from *Acanthus mollis* seeds inhibit velvetleaf germination and growth. *J. Nat. Prod.* **1985**, *48*, 59–63.
- (7) Cambier, V.; Hance, T.; De Hoffmann, E. Noninjured maize contains several 1,4-benzoxazin-3-one related compounds but only as glucoconjugates. *Phytochem. Anal.* **1999**, *10*, 119–126.
- (8) Woodward, M. D.; Corcuera, L. J.; Helgeson, J. P.; Upper, C. D. Decomposition of 2,4-dihydroxy-7-methoxy-2H-1,4-benzoxazin-3(4H)-one in aqueous solutions. *Plant Physiol.* **1978**, *61*, 796–802.
- (9) Macías, F. A.; Oliveros-Bastidas, A.; Marín, D.; Castellano, D.; Simonet, A. M.; Molinillo, J. M. G. Degradation Studies on Benzoxazinoids. Soil Degradation Dynamics of 2,4-Dihydroxy-7-methoxy-(2H)-1,4-benzoxazin-3(4H)-one (DIMBOA) and Its Degradation Products, Phytotoxic Allelochemicals from Gramineae. *J. Agric. Food Chem.* **2004**, *52*, 6402–6413.
- (10) Macías, F. A.; Oliveros-Bastidas, A.; Marín, D.; Castellano, D.; Simonet, A. M.; Molinillo, J. M. G. Degradation studies on benzoxazinoids. Soil degradation dynamics of (2R)-2-O-beta-D-glucopyranosyl-2,4-dihydroxy-(2H)-1,4-Benzoxazin-3(4H)-one (DIBOA-Glc) and its degradation products, phytotoxic allelochemicals from Gramineae. *J. Agric. Food Chem.* **2005**, *53*, in press.
- (11) Peng, S.; Chilton, W. S. Biosynthesis of DIMBOA in maize using deuterium oxide as a tracer. *Phytochemistry* **1994**, *37*, 167–171.
- (12) Kumar, P.; Moreland, D. E.; Chilton, W. S. 2H-1,4-benzoxazin-3(4H)-one, an intermediate in the biosynthesis of cyclic hydroxamic acids in maize. *Phytochemistry* **1994**, *36*, 893–898.
- (13) Bravo, R.; Lazo, W. Antialgal and antifungal activity of natural hydroxamic acids and related compounds. *J. Agric. Food Chem.* **1996**, *44*, 1569–1571.
- (14) Sahi, S. V.; Chilton, M.; Chilton, W. S. Corn metabolites affect growth and virulence of *Agrobacterium tumefaciens*. *Proc. Natl. Acad. Sci. U.S.A.* **1990**, *87*, 3879–3883.
- (15) Zikmundova, M.; Drandarov, K.; Bigler, L.; Hesse, M.; Werner, C. Biotransformation of 2-benzoxazolinone and 2-hydroxy-1,4-benzoxazin-3-one by endophytic fungi isolated from *Aphelandra tetragona*. *Appl. Environ. Microb.* **2002**, *68*, 4863–4870.
- (16) Gagliardo, R. W.; Chilton, W. S. Soil transformation of 2(3H)-benzoxazolone of rye into phytotoxic 2-amino-3H-phenoxazin-3-one. *J. Chem. Ecol.* **1992**, *18*, 1683–1691.
- (17) Kumar, P.; Gagliardo, R. W.; Chilton, W. S. Soil transformation of wheat and corn metabolites MBOA and DIM2BOA into aminophenoxazinones. *J. Chem. Ecol.* **1993**, *19*, 2453–2461.
- (18) Friebe, A.; Vilich, V.; Hennig, L.; Kluge, M.; Sicker, D. Detoxification of benzoxazolinone allelochemicals from wheat by *Gaeumannomyces graminis* var. tritici, *G. graminis* var. graminis, *G. graminis* var. avenae, and *Fusarium culmorum*. *Appl. Environ. Microb.* **1998**, *64*, 2386–2391.
- (19) Yue, Q.; Bacon, C. W.; Richardson, M. D. Biotransformation of 2-benzoxazolinone and 6-methoxy-benzoxazolinone by *Fusarium moniliforme*. *Phytochemistry* **1998**, *48*, 451–454.
- (20) Macias, F. A.; Castellano, D.; Molinillo, J. M. G. Search for a standard phytotoxic bioassay for allelochemicals. Selection of standard target species. *J. Agric. Food Chem.* **2000**, *48*, 2512–2521.
- (21) Larsen, E.; Christensen, L. P. Simple method for large scale isolation of the cyclic arylhydroxamic acid DIMBOA from maize (*Zea mays* L.). *J. Agric. Food Chem.* **2000**, *48*, 2556–2558.
- (22) Barnes, J. P.; Putnam, A. R. Role of benzoxazinones in allelopathy by rye (*Secale cereale* L.). *J. Chem. Ecol.* **1987**, *13*, 889–906.
- (23) Hashimoto, Y.; Ishizaki, T.; Seudo, K.; Okamoto, T. Rearrangement of 4-acetoxy-2H-1,4-benzoxazin-3(4H)-one. *Chem. Pharm. Bull.* **1983**, *31*, 3891–3896.
- (24) Atkinson, J.; Morand, P.; Arnason, J. T.; Niemeyer, H. M.; Bravo, H. R. Analogues of the cyclic hydroxamic acid 2,4-dihydroxy-7-methoxy-2H-1,4-benzoxazin-3-one (DIMBOA): decomposition to benzoxazolinones and reaction with  $\beta$ -mercaptoethanol. *J. Org. Chem.* **1991**, *56*, 1788–1800.

- (25) Keck, G. E.; Wager, T. T.; McHardy, S. F. Reductive cleavage of N–O bonds in hydroxylamines and hydroxamic acid derivatives using samarium diiodide. *Tetrahedron* **1999**, *55*, 11755–11772.
- (26) Castellano, D.; Macías, F. A.; Castellano, M.; Cambroner, R. FITOMED (*Automated system for the measurement of variable lengths*). Patent No. P9901565.
- (27) Macías, F. A.; Velasco, R. F.; Viñolo, V. M. I.; Castellano, D.; Galindo, J. C. G.; Molinillo, J. M. G. Cluster analysis. A valuable tool for allelopathic SAR studies? In *Allelopathy: from molecules to ecosystems*; Reigosa, M. J., Pedrol, N., Eds.; Science Publishers, Inc.: Enfield, NH, 2002.
- (28) Ghose, A. K.; Pritchett, A.; Crippen, G. M. Atomic physico-chemical parameters for three-dimensional structure directed quantitative structure–activity relationships III: modeling hydrophobic interactions. *J. Comput. Chem.* **1988**, *9*, 80–90.
- (29) Sánchez-Moreiras, A. M.; Coba de la Peña, T.; Martínez, A.; González, L.; Pellisier, F.; Reigosa, M. J. Mode of action of the hydroxamic acid BOA and other related compounds. In *Allelopathy*; Macías, F. A., Ed.; CRC Press LLC: Boca Raton, FL, 2004; pp 239–252.
- (30) Glawischmig, E.; Grün, S.; Frey, M.; Gierl, A. Cytochrome P450 monooxygenases of DIBOA biosynthesis: specificity and conservation among grasses. *Phytochemistry* **1999**, *50*, 925–930.
- (31) Fomsgaard, I. S.; Mortensen, A. G.; Carlsen, S. C. K. Microbial transformation products of benzoxazolinone and benzoxazinone allelochemicals—a review. *Chemosphere* **2004**, *54*, 1025–1038.
- (32) Lipinski, C. A.; Lombardo, F.; Dominy, B. W.; Feeney, P. J. Experimental and computational approaches to estimate solubility and permeability in drug discovery and development settings. *Adv. Drug Delivery Rev.* **2001**, *46*, 3–26.
- (33) Tice, C. M. Selecting the right compounds for screening: Does Lipinski's rule of 5 for pharmaceuticals apply to agrochemicals? *Pest Manage. Sci.* **2001**, *57*, 3–16.
- (34) Barnes, J. P.; Putnam, A. R.; Burke, B. A. Allelopathy activity of rye (*Secale cereale* L.). In *The Science of Allelopathy*; Putnam, A. R., Tang, C. S., Eds.; Wiley-Interscience: New York, 1986; pp 271–286.
- (35) Sicker, D.; Frey, M.; Schulz, M.; Gierl, A. Role of natural benzoxazinones in survival strategies of plants. In *International review of cytology—A survey of cell biology*; Jeong, K. W., Ed.; Academic Press: San Diego, CA, 2000; Vol. 198, pp 319–346.

---

Received for review September 22, 2004. Revised manuscript received November 19, 2004. Accepted November 22, 2004.

JF0484071